

Ultra High Performance Liquid Chromatograph

Nexera X2





Nexera X2

Ultra High Performance Liquid Chromatograph

Maximizing the Potential of UHPLC/HPLC Analysis

Meet the Nexera X2, the most advanced UHPLC available today. The flexible system design achieves a true fusion between UHPLC and HPLC technologies, enabling the Nexera X2 to be used for a much broader range of applications. This completely new UHPLC system not only offers maximum speed, sensitivity, resolution, stability, and reliability, it also features a revolutionary *i*-PDeA* separation technology and an *i*-DReC** function that extends the dynamic range so that both concentrated and trace components can be quantitated simultaneously.

* intelligent Peak Deconvolution Analysis (patent pending)

** intelligent Dynamic Range Extension Calculator (patent pending)

Nexera X2 Series

The flexible module design allows you to choose an optimal Nexera X2 system according to your analytical needs. Some typical configurations are shown below.



Nexera SR System

This UHPLC system offers maximum sensitivity and resolution. It features the new *i*-PDeA* separation method.
* intelligent Peak Deconvolution Analysis



Nexera Quaternary System

This system enables four-solvent gradient analysis, making it especially easy to migrate methods from general-purpose HPLC systems.



Nexera Method Scouting System

Providing comprehensive support for method development, this system is capable of automatically developing methods using up to 96 different combinations of mobile phases and columns.



Nexera UHPLC/HPLC System

This system offers complete UHPLC and HPLC capabilities in a single system by automatically switching between mixers and columns.



Nexera MP System

This LC/MS front-end UHPLC system is ideal for high-throughput multi-analyte analysis. Combine the Nexera X2 with a UFMS unit to achieve ultrafast LC/MS/MS analysis.

Nexera X2 Components



CBM-20A

The CBM-20A is a network-compatible controller capable of monitoring systems from a separate room. In addition to Nexera X2 systems, it can be used to integrate the control of a variety of components to create a customized system tailored to specific analytical objectives.

Solvent Delivery Unit



LC-30AD

Adding this four-solvent gradient unit allows you to use a wide variety of delivery methods. It is also capable of blending mobile phases for automated mobile phase preparation.

Autosamplers



SIL-30AC

This multifunctional model is capable of pretreatment and trap injection methods.



SIL-30AC / Rack Changer II

Together with this rack changer, the autosampler accommodates up to 12 plates.



SIL-30ACMP

This open-access autosampler accommodates up to six plates.

Column Ovens



CTO-30A

Temperature controllable up to 150°C (Max. column length: 150 mm)



CTO-20AC

Large-capacity column oven capable of housing multiple columns and valves (Max. column length: 300 mm)



CTO-30AS

Space-saving column oven for use as an MS front end (Max. column length: 50 mm)

Detector



SPD-M30A

Achieves maximum sensitivity and separation.

While achieving high sensitivity and low dispersion, this photodiode array detector features the new *i*-PDeA* separation function and the *i*-DReC** dynamic range extension function. Its temperature-controlled optical system provides outstanding stability for true high-speed analysis.

* intelligent Peak Deconvolution Analysis

** intelligent Dynamic Range Extension Calculator

Higher Sensitivity and Resolution Than Ever Before



Nexera SR System

The SPD-M30A photodiode array detector included in Nexera SR systems has been completely redesigned from previous models and features uncompromised improvements throughout the design, from the cell structure to the temperature control method. This not only increases the sensitivity of UHPLC systems, but also improves the sensitivity and separation of HPLC systems, making it suitable for the flagship model of the Nexera X2 series.

▶ Detector Cell Offers Both Sensitivity and Resolution

While the SR-Cell (sensitivity and resolution cell) used in the SPD-M30A has an optical path length of 10 mm, it features low-dispersion specifications compared with previous models. It achieves sharper peaks in UHPLC analysis while remaining just as easy to use for HPLC as before, and can be used for a wide range of applications from UHPLC to HPLC.

Analytical Conditions

Flow rate	1.0 mL/min
Column	Shim-pack XR-ODS II (75 mmL. × 2.0 mmI.D., 2.2µm)

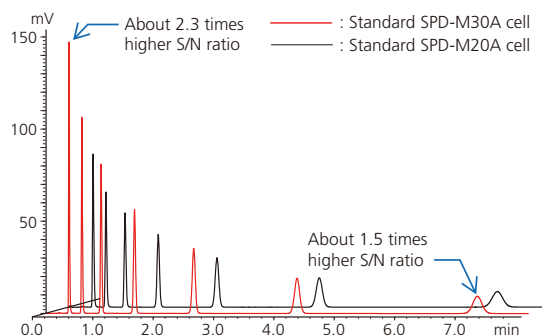

▶ Even Higher Sensitivity with an Optional Cell

While the optional high-sensitivity cell features an optical path length of 85 mm, the noise level is kept to a minimum. The improved S/N ratio enables analysis of trace impurities and trace components, which was not possible before.

Analytical Conditions

Mobile Phase	A) 20 mmol/L phosphate buffer solution with pH 2.8 B) Acetonitrile
Column	Shim-pack XR-ODS II (150 mmL. × 3.0 mmI.D.)
Sample	Cefazolin sodium

Comparison of Signal Strength

	High-Sensitivity Cell	Standard Cell
Impurity 1	49109	7931
Impurity 2	81339	11438
Impurity 3	16345	2290
Impurity 4	37922	5548
Impurity 5	7726	968

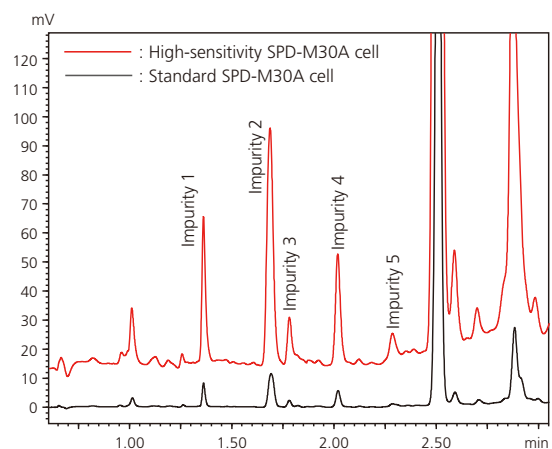

▶ Not Just Sensitivity — High Data Reliability

The SPD-M30A adopts the new temperature-controlled TC-Optics with the SR-Cell, which has an optimized heat exchange inlet pipe. These features achieve faster stabilization with low external dispersion for UHPLC analysis.

The faster stabilization shortens the “wait time” for analysis, thereby increasing total analytical throughput.

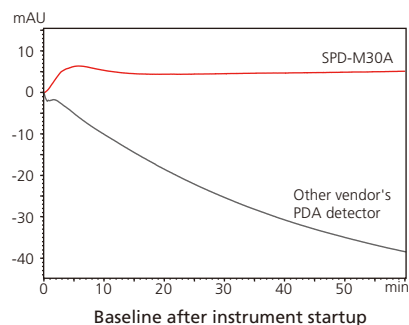

▶ Excellent Stability Even with Subtle Changes in Room Temperature

Subtle fluctuations in room temperature are unavoidable, even in temperature-controlled laboratories. Incorporating TC-Optics, which provides a stable baseline even if the room temperature fluctuates, the SPD-M30A provides highly reliable data.

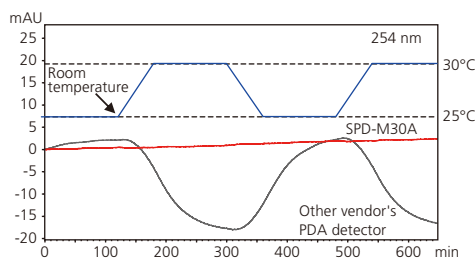

▶ Superior spectrum resolution and linearity

The SPD-M30A provides unrivaled spectrum resolution by adopting an optimized optic system. A benzene spectrum is often used for evaluation of spectrum resolution.

The SPD-M30A offers the world's highest* spectrum resolution, $B/A = 2.90$.

* As of November 2012, according to Shimadzu survey.

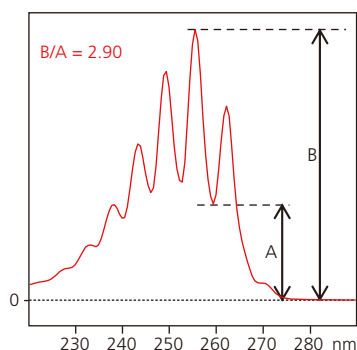

In addition, the new signal treatment technology realizes excellent spectrum linearity across a wide area from low to high concentration. The SPD-M30A supports analyses, such as purity analysis, that require a wide dynamic range.

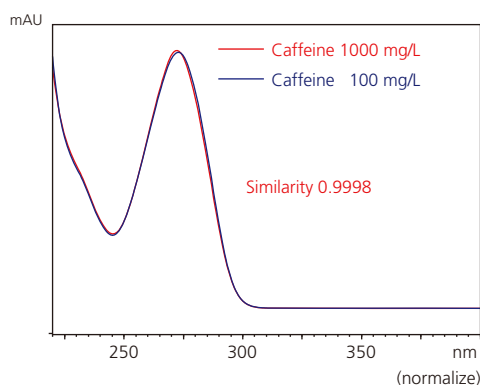

▶ SPD-M30A — Ideal for Both UHPLC and HPLC

Needless to say, Nexera family SPD-M30A detectors can be installed in Shimadzu Prominence series HPLC systems as well. Each year, users continue to demand higher sensitivity, not only for food products and chemicals, but in other fields as well.

The SPD-M30A detector is ideal for all sorts of fields.



SPD-M30A

High-Performance Autosamplers Facilitate Ultra High Sensitivity Analysis

Popular Low-Carryover Performance Now Further Improved

Nexera X2 series autosamplers are carefully designed to reduce carryover in increasingly high-sensitivity analytical applications, with features such as a multi-rinse mechanism, included as standard, that allows you to select from multiple types of solvents. They also offer high accuracy at the injection volumes optimal for column sizes typically used in UHPLC applications. Together with the broad injection volume linearity, this makes Nexera X2 series autosamplers more than capable of handling applications from UHPLC to HPLC.



Multi-Rinse Mechanism Eliminates Carryover

When analyzing multiple components simultaneously, they often have significantly different polarities. In such cases, a single rinse solution is insufficient for adequate rinsing. To solve this problem, Nexera X2 series SIL-30AC and SIL-30ACMP autosamplers feature a hardware structure that resists adsorption as well as a rinse mechanism that minimizes carryover.

Multi-rinse mechanism supports up to 4 solutions

The needle surface can be rinsed by a maximum of two rinse solutions and the needle inner surface can be rinsed by a maximum of three rinse solutions. Of course, rinsing with just one solution in the usual way is also possible. The rinsing order can be set as desired.

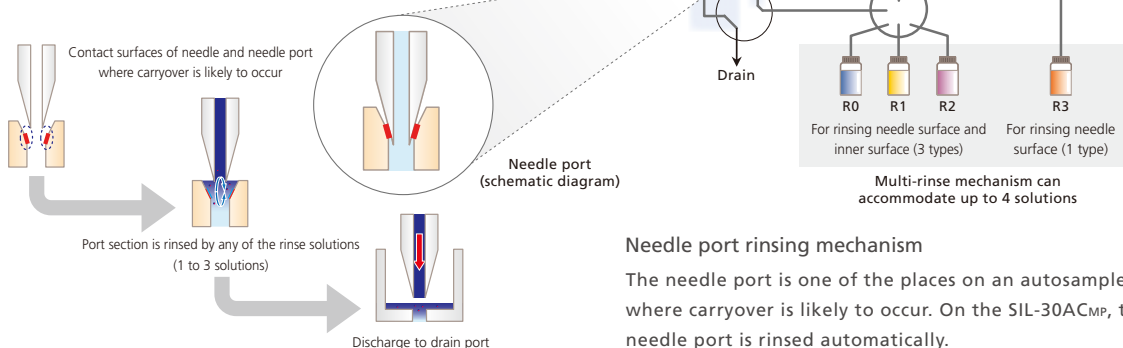

Needle port rinsing mechanism

The needle port is one of the places on an autosampler where carryover is likely to occur. On the SIL-30ACMP, the needle port is rinsed automatically.

HPLC detectors, such as mass spectrometers, are becoming increasingly sensitive each year. Consequently, the carryover levels required for HPLC systems are becoming extremely strict. Nexera X2 series SIL-30AC and SIL-30ACMP autosamplers offer the ultimate in low-carryover performance, due to the thorough carryover-reducing mechanism.

Ultralow carryover achieved without rinsing

When rinsing is performed to keep carryover low, the total analysis time sometimes increases as the number of analyses increases. Nexera autosamplers excel in suppressing carryover even without rinsing.

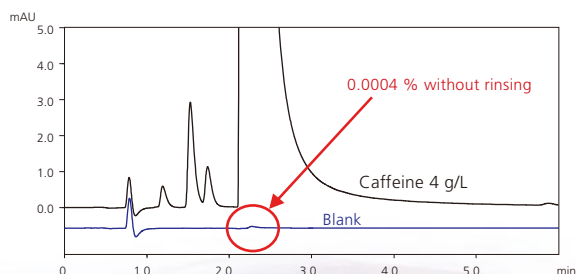

Ultralow carryover even on a high-sensitivity LC/MS/MS

Ultralow carryover performance is required with LC/MS systems. The SIL-30ACMP demonstrates exceptional carryover performance even on compounds such as chlorhexidine that are very prone to adsorption. Moreover, the SIL-30ACMP features an improved rinsing mechanism to achieve even lower carryover.

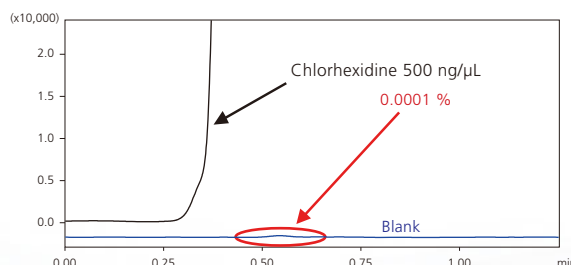

▶ Broad Injection Volume Range Enables Both UHPLC and HPLC

Nexera X2 series autosamplers offer excellent injection reproducibility over a wide range of injection volumes. Applications in the UHPLC to HPLC region require a diverse range of analytical column sizes. Using a Nexera X2 series autosampler allows you to choose the optimal injection volume for the given column size, without any compromise in analytical reliability.

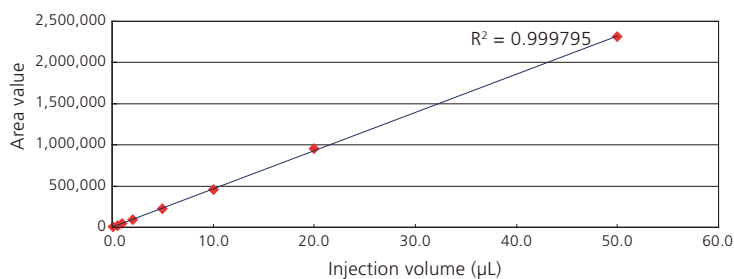

Injection Volume (µL)	Repeatability (n = 6)
0.1	0.67%
0.2	0.32%
0.5	0.26%
0.7	0.14%
1	0.11%

Injection Volume (µL)	Repeatability (n = 6)
2	0.09%
5	0.05%
10	0.05%
20	0.04%
50	0.03%

Injection Repeatability (Actual Values)

▶ Accurate Analysis Even at Volumes Below 1 µL

Nexera X2 series autosamplers enable highly accurate analysis even at injection volumes below 1 µL. For UHPLC analysis using small columns, the optimal injection volumes are correspondingly small as well. Especially when using sample solvents with a high elution strength, it is difficult to increase the injection volume. Normally, that means samples must be diluted to reduce the effects of the sample solvents. Nexera X2 series autosamplers are capable of highly accurate micro volume injection, allowing even samples with high organic solvent concentrations after pretreatment to be injected directly without dilution.

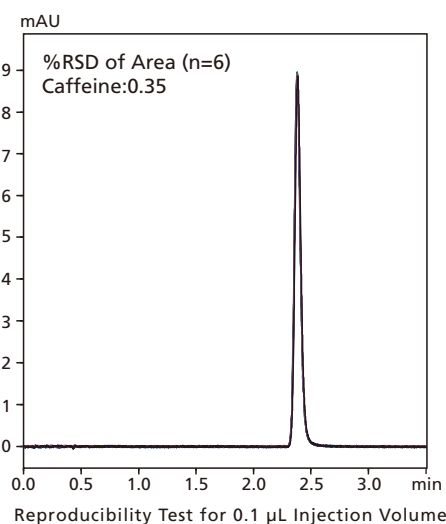

▶ Easily Accommodates a Large Number of Samples

If a large number of samples needs to be placed at the same time and their temperature must be kept constant, then an optional Rack Changer II for the SIL-30AC is especially useful. This rack changer can hold up to 12 microplates (96/384-well MTPs or DWPs) or 1.5 mL vial racks, which provides ample capacity for large numbers of samples.



Rack Changer II

True High-Throughput Analysis

▸ Nexera MP System — Ideal as an LC/MS Front-End LC

The Nexera MP system, equipped with the SIL-30AC_{MP} autosampler, serves as a high-performance front-end LC to maximize the performance of LC/MS systems. In the standard configuration, six microplates (96/384-well MTPs or DWPs) or 1.5 mL vial racks can be used. This provides an open access system that allows you to use different plates for each rack and place samples at any time, even during sample injection, except on the rack being used for injection. Just as with the SIL-30AC, thorough measures have been taken to minimize carryover, which makes it an ideal system for use as a front-end LC for LC/MS systems.



Nexera MP System Sample Processing Capacity

Plate Type	Number of Samples Processed
1.5 mL vial plates	324
96-well plates	576
384-well plates	2304

Note: In addition to the above, ten 1.5 mL vials can be used.



The Nexera MP system is able to access samples via the quickest path by moving the needle in both X and Y directions simultaneously. This achieves higher injection speeds than ever before, with shortest injection time being about 7 seconds.

▸ Improved Overall Analysis Throughput

Even on current models, use of the SIL-30AC_{MP} speeds up analysis. The following example shows that the analysis time can be shortened by at least 2 hours when an injection is performed 1000 times using the SIL-30AC_{MP}.

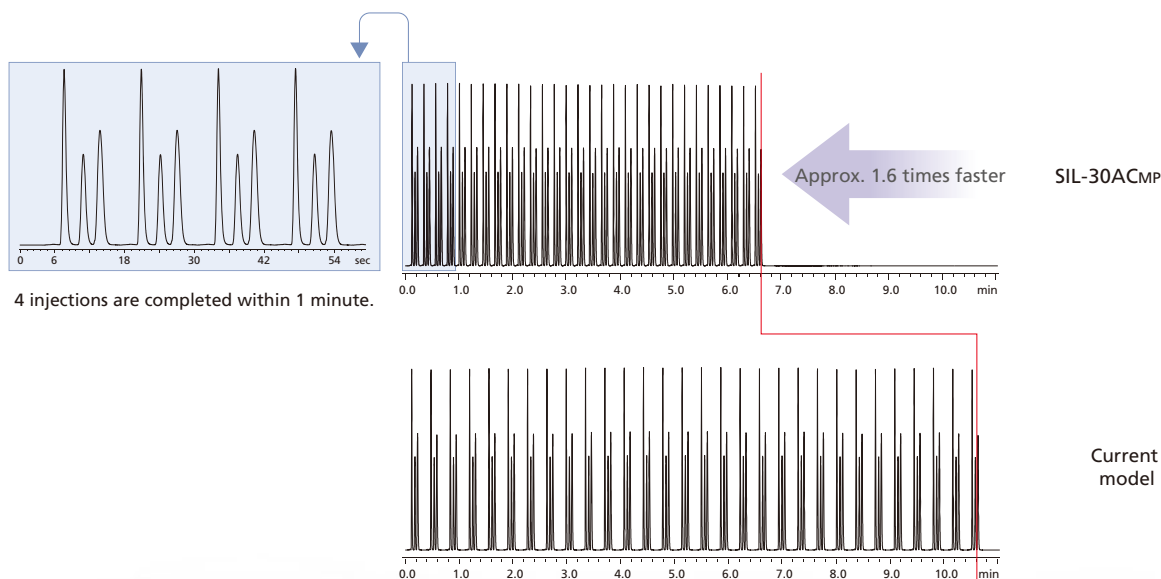

Comparison When Up to 30 Injections Are Performed

A New Standard Nexera X2 System

▸ Nexera Quaternary System Enables Low-Pressure Gradient Analysis Using Four Solvents — Useful for Method Development

The Nexera Quaternary system is able to deliver low-pressure gradient mixtures of four solvents. Its ability to load up to four types of mobile phases in a single solvent delivery unit eliminates the time and trouble of exchanging mobile phases during method development. If a low-pressure gradient unit is added to a system with two solvent delivery units, then both binary and quaternary capabilities can be achieved in a single system, which can help improve instrument utilization efficiency.



▸ Smooth Migration from General-Purpose HPLC Systems

The Nexera X2 offers both UHPLC and HPLC capabilities with a single system. Basic Nexera Quaternary system configurations with one solvent delivery unit are capable of gradient analysis using up to four solvents. Furthermore, existing HPLC methods can not only be reproduced on the system, but also migrated to UHPLC methods.

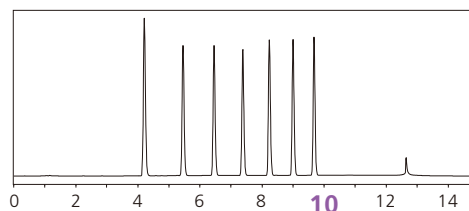
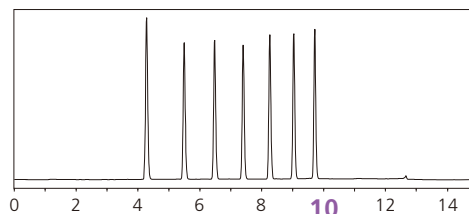

Analytical Conditions

Column	Shim-pack VP-ODS (150 mL, x 4.6 mm I.D., 4.6 μm)
Flow rate	1.0 mL/min (gradient elution)

▸ Up to 16 Possible Mobile Phase Combinations

If a Nexera Quaternary system equipped with two solvent delivery units is available, then four different mobile phases can be loaded for each solvent delivery unit, which means a maximum of 16 mobile phase combinations can be considered. Since that eliminates the manual operations needed to exchange mobile phases each time mobile phase conditions are changed, it can reduce the amount of labor hours required to prepare mobile phases.

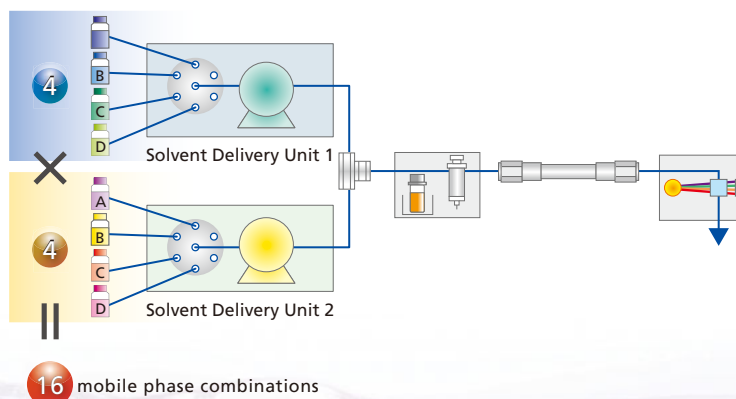

Simplifies Time-Consuming Method Development Processes

▸ Nexera Method Scouting System Automates Method Development Processes

The Nexera Method Scouting method development system, which can accommodate up to six columns and eight mobile phases, is capable of automatically switching between up to 96 combinations of columns and mobile phases. This means data can be acquired even at night, which is typically down-time, thus making highly efficient method development possible.

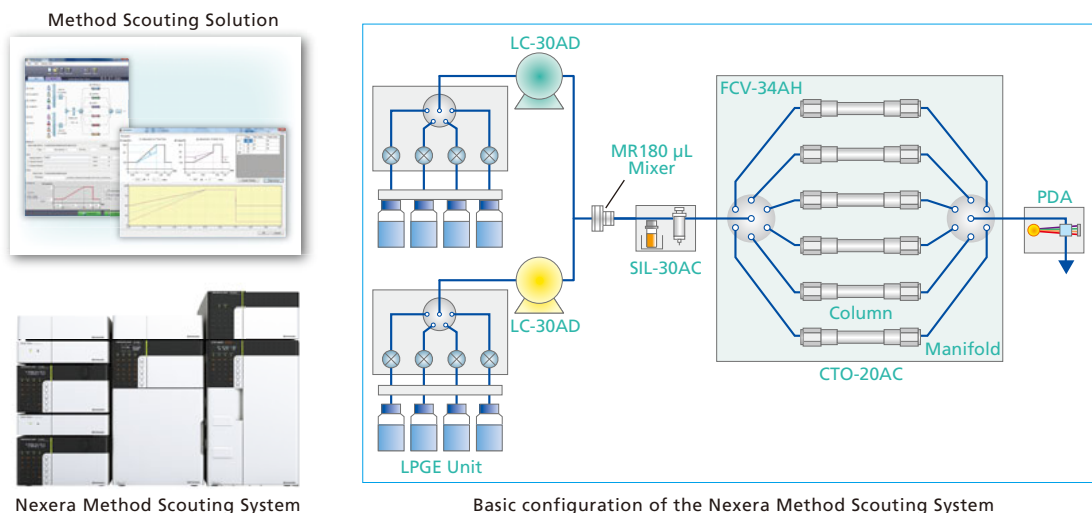

▸ Not Only Automates Data Acquisition, but Significantly Reduces Labor Required for Preparation

The Nexera Method Scouting system is not only able to significantly reduce the labor hours required for preparation, it also helps avoid human error involved in configuring method file and schedule settings. Considering it can accommodate up to six columns, eight types of mobile phases, and 10 types of gradient settings, it is potentially capable of providing 960 combinations. Configuring method file and schedule settings manually would not only take time, but could result in inadvertent errors.

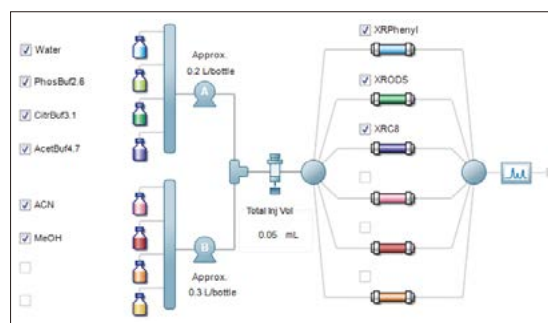

Solvents used in mobile phase blending can also be managed in a database, in the same manner as for scouting. This allows you to select them conveniently via a graphical user interface.

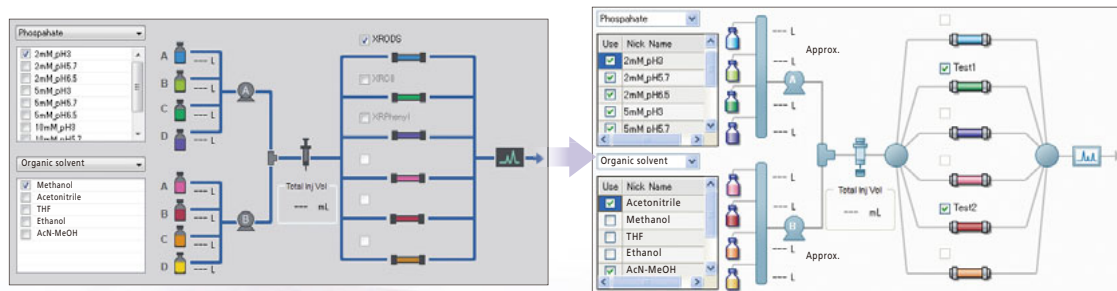

Outstanding Expandability Broadens Applicability

▸ UHPLC/HPLC Switching System Allows a Single System to Handle Both UHPLC and HPLC

This system is especially useful for users that want to quickly develop methods with UHPLC and then deploy those methods horizontally to existing HPLC systems. By using a flow line switching valve to automatically switch between dedicated UHPLC and HPLC mixers, a single LC system can be used for both UHPLC and HPLC applications, thus reducing the costs of introducing and maintaining additional systems.

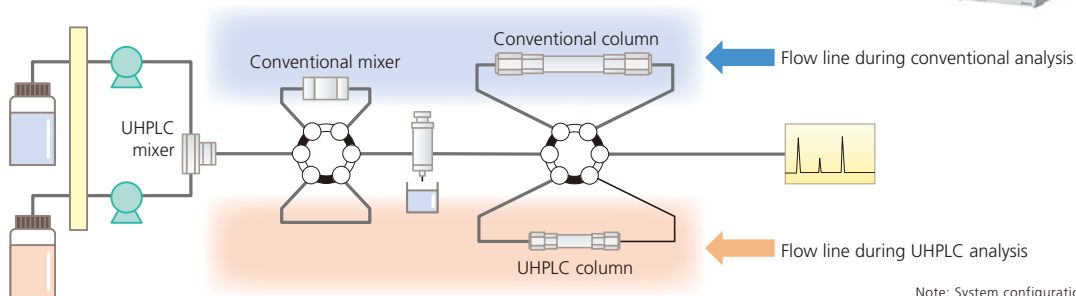

Note: System configuration example

▸ 130 MPa Pressure Capacity of the Flow Line Switching Valve Accommodates a Wider Range of Applications

The 130 MPa capacity FCV-32AH flow line switching valve employs the same high-pressure-resistance technology as autosamplers, so it can be used for a wide range of applications, from UHPLC to HPLC. Since the FCV-32AH can be installed inside column ovens or connected to systems externally, it is useful for a broad range of applications, such as column switching or 2-dimensional LC.



▸ High-Efficiency Gradient Mixers Ensure Reliable Mobile Phase Mixture

The Nexera X2 systems feature microreactor type gradient mixers that are able to mix small quantities of mobile phases with high efficiency. In addition to a 20 μL mixer that is ideal for MS front-end LC units and a 180 μL mixer that offers maximum mixing efficiency, 40 μL and 100 μL models are also available that these provide a balance between mixing performance and gradient delay, allowing you to select an optimal capacity.

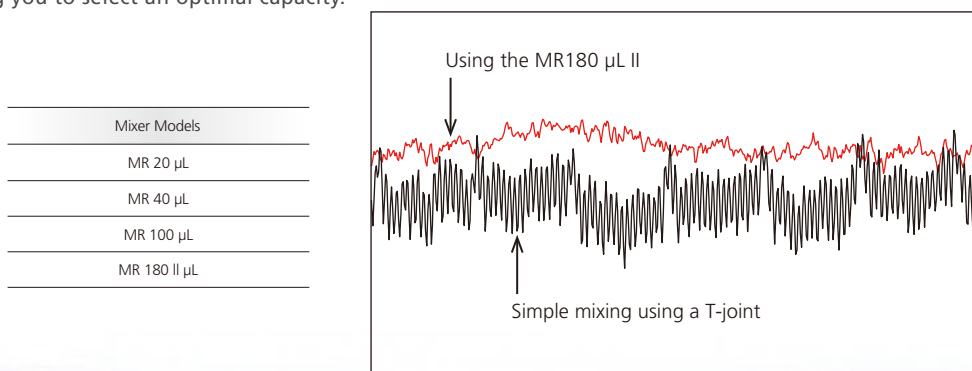

Achieves a baseline with minimal undulations, even for concentrated buffer solutions.

Improved Efficiency of Non-Analytical Tasks

Autosampler Pretreatment Function Automates Sample Preparation

Creating calibration curves is essential for quantitative analysis, and is a critical process that must not be compromised if concentrations are to be measured correctly. By using the Nexera X2 SIL-30AC autosampler and Shimadzu workstation, simply place standard stock solution samples and unknown samples in position, and the system automatically does the rest, from the time-consuming process of preparing calibration curves to calculating quantitative results. (The SIL-30AC autosampler offers automatic pretreatment capability.)

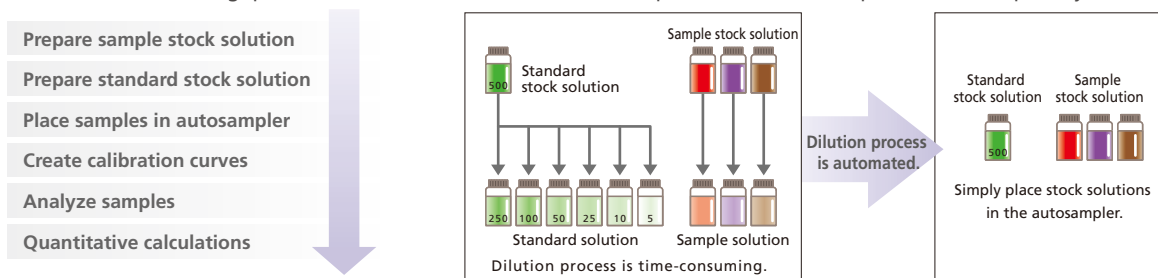

Automatically performs everything from creating calibration curves to calculating quantitative results.

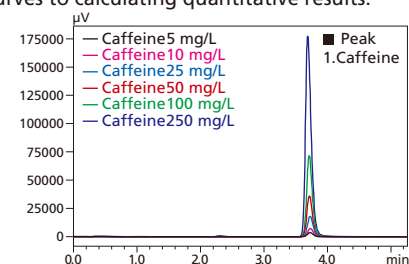

Chromatograms are obtained from automatically diluted standard stock solutions.

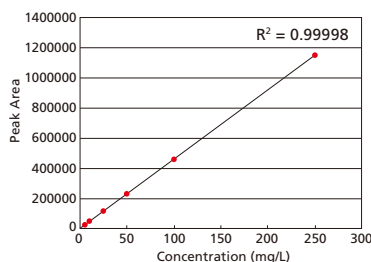

A calibration curve is also created automatically from the resulting chromatograms for standard stock solutions.

Automated Pre-Column Derivatization Reaction

The Nexera X2 SIL-30AC autosampler is also capable of automating pre-column derivatization reactions. Because reaction times and reagent amounts added can be kept constant, it enables highly reproducible derivatization reactions. In addition, automating the process eliminates the time and trouble of derivatization. The analytical example below shows how 22 amino acid components were analyzed with excellent sensitivity, by using two types of reagents to automatically derivatize amino acids and using the automatic wavelength switching function of the RF-20Axs fluorescence detector.

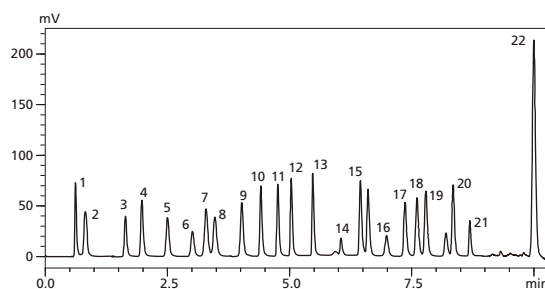

- Peaks
 1. Aspartic Acid 2. Glutamic Acid 3. Asparagine 4. Serine 5. Glutamine 6. Histidine
 7. Glycine 8. Threonine 9. Citrulline 10. Arginine 11. Alanine 12. GABA 13. Tyrosine
 14. Cys-Cys 15. Valine 16. Methionine 17. Tryptophan 18. Phenylalanine 19. Isoleucine
 20. Leucine 21. Lysine 22. Proline

Analytical Conditions

Column	: YMC-Triart C18 1.9 μ m (75 mL. \times 3.0 mmI.D., 1.9 μ m, YMC Co., Ltd.)
Mobile Phase	: A : 20 mmol/L Phosphate Potassium Buffer (pH 6.9) B : 45/40/15 Acetonitrile/Methanol/Water
Time Program	: B Conc. 11 % \rightarrow 13 % (0.00–3.00 min) \rightarrow 31 % (5.00 min) \rightarrow 37 % (7.5 min) \rightarrow 70 % (10.00 min) \rightarrow 100 % (10.50–13.50 min) \rightarrow 11 % (14.00 min)
Flow Rate	: 0.8 mL/min
Column Temp.	: 35°C
Injection Volume	: 1 μ L
Detection	: RF-20Axs Ex. at 350 nm, Em. at 450 nm \rightarrow Ex. at 266 nm, Em. at 305 nm (9.0 min)
Cell Temp.	: 20°C
Flow Cell	: Conventional Cell

Note: For more details, refer to Application News (L432).

Repeatability

	Area%RSD		Area%RSD
Asp	0.50	GABA	0.41
Glu	0.48	Tyr	0.55
Asn	0.51	Cys-Cys	0.46
Ser	0.41	Val	0.71
Gln	0.56	Met	0.71
His	0.57	Trp	0.70
Gly	0.29	Phe	0.73
Thr	0.55	Ile	0.63
Citrulline	0.46	Leu	0.55
Arg	0.45	Lys	0.56
Ala	0.46	Pro	2.35

Reducing the Time Required for Preparing Mobile Phases

Mobile Phase Blending Function — Convenient for Frequent Mobile Phase Changes During Method Development and Robustness Evaluation

With its flexibility in solvent delivery methods, the Nexera X2 offers a mobile phase blending function capable of blending solvents at any mixture ratio desired. Mobile phase blending can be used to automate preparing buffer solutions, diluting solvents, adding acids, and so on. Method development or robustness evaluation may require preparing many different types of mobile phases in small quantities. In such cases, the mobile phase blending function can be used to automatically prepare only the amounts necessary for analysis. This helps reduce not only the amount of work required for preparation but also the solvent consumption, thus making the process more environmentally friendly.

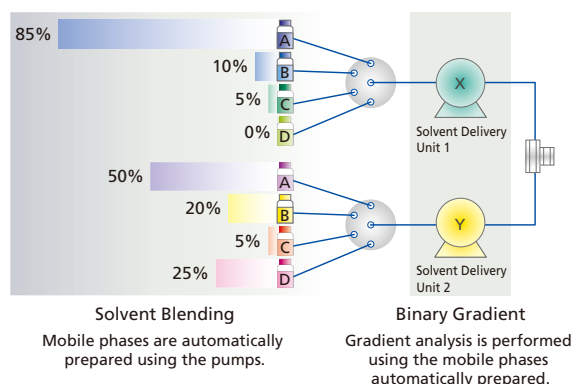

Example of Mobile Phase Evaluation

This is an example of simultaneous analysis of non-steroidal anti-inflammatory drugs (NSAIDs). The method was evaluated by loading the system with a total of five solvents—three used to prepare the phosphate buffer solution for solvent delivery unit X and two (acetonitrile and methanol) for solvent delivery unit Y.

Mobile phase for solvent delivery unit X: A) Water; B) 20 mmol/L aqueous phosphate solution; C) 20 mmol/L aqueous disodium phosphate solution
Mobile phase for solvent delivery unit Y: A) Acetonitrile; B) Methanol

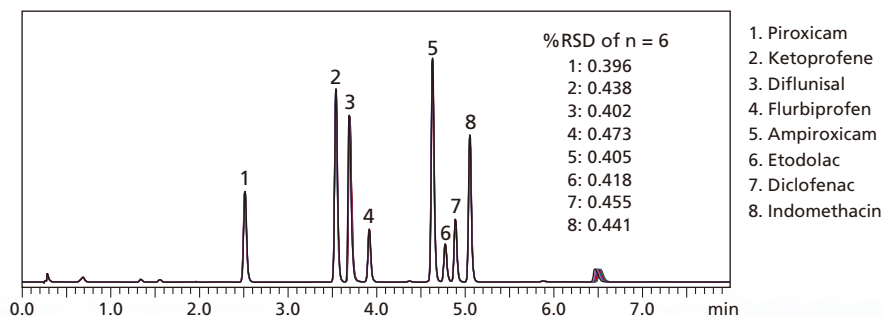
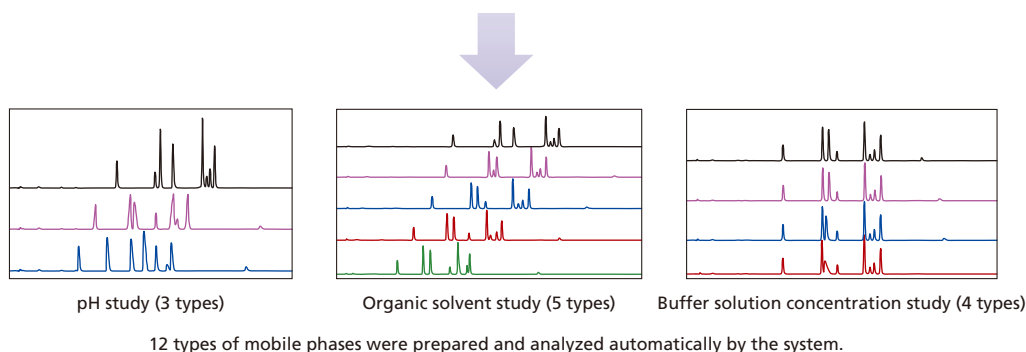

Repeatability was analyzed under conditions that provided good peak separation (n = 6).



Shimadzu Chromatography Workstation

LabSolutions

Modifications Made Throughout the System to Improve Work Efficiency



Automatic Execution to Fully Utilize Ultrafast Speed of UHPLC Analysis

LabSolutions can be used to purge mobile phases, wait for baselines to stabilize, dilute standard samples, and even prepare calibration curves, all automatically. Consequently, the instrument can be operated overnight, when there are no operators, to maximize the utilization rate.



Automatically purges mobile phases

Automatically waits for baselines to stabilize



Analysis Window Includes a Chromatogram Monitor So the Desired Information Can Be Viewed Immediately

Not only does it display chromatograms in real time from various detectors, it also displays other information before and during analyses, such as pressure, room temperature, and the gradient program, in an easy-to-understand manner on a single monitor. Therefore, the current instrument status and method settings can be accessed via a single window, which makes it easy to see what needs to be done next.

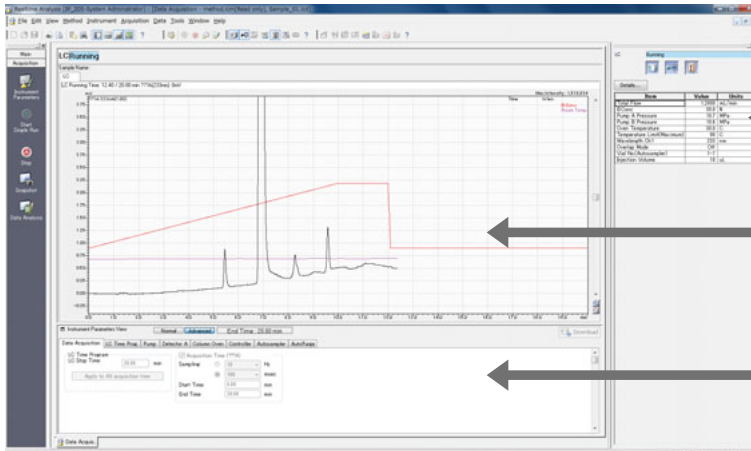

- Status monitor indicates the current instrument status
- The gradient program and other instrument status log information can be displayed simultaneously with chromatograms
- Method parameter tabs can be used to switch between units

Analysis Window (Quant Browser) Instantly Displays the Pass/Fail Status with Respect to Chromatograms, Statistical Results, or Reference Values

In addition to confirming a list of multiple data acquired by batch analysis, the Quant Browser provides the ideal solution for customers that want to immediately confirm the appropriateness of large amounts of acquired analytical data. This window also enables peak integration. Therefore, it significantly improves work efficiency compared to checking each data individually.

Peaks can be integrated while viewing statistical results

Displays statistical results for multiple data

Calibration curve information can be verified at the same time

Displays chromatogram for selected data

Data Browser Makes It Easy to View and Compare Multiple Data Side by Side

Using the Data Browser allows viewing multiple analytical results while confirming chromatograms and peak information.

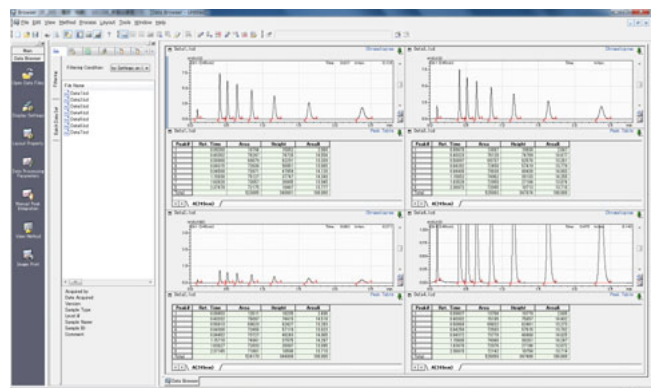

Automatically* keeps diluting standard samples and even prepares calibration curves
 *Automatic function available only with the SIL-30AC

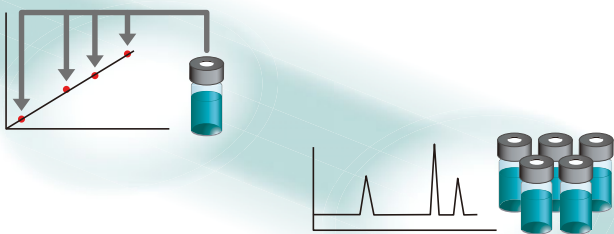

Automatically analyzes target samples through to performing quantitative analysis

Batch Analysis Results Can Be Analyzed by Postrun Batch Analysis

Individually analyzing batch analysis results by postrun analysis is a waste of valuable time. To address this, LabSolutions performs postrun batch analysis. This is perfect for re-confirming results by changing peak integration parameters slightly, for example.

Automatically outputs results to PDF or paper

Revolutionary Spectral Analysis Processing

► Complete Separation of Co-eluted Peaks by *i*-PDeA (intelligent Peak Deconvolution Analysis, patent pending)

i-PDeA enables the extraction of a single peak from co-eluted peaks by utilizing differences in spectra. This new separation method removes discussion of integration methods for co-eluted peaks. The *i*-PDeA also helps detect impurity peaks in a target peak.

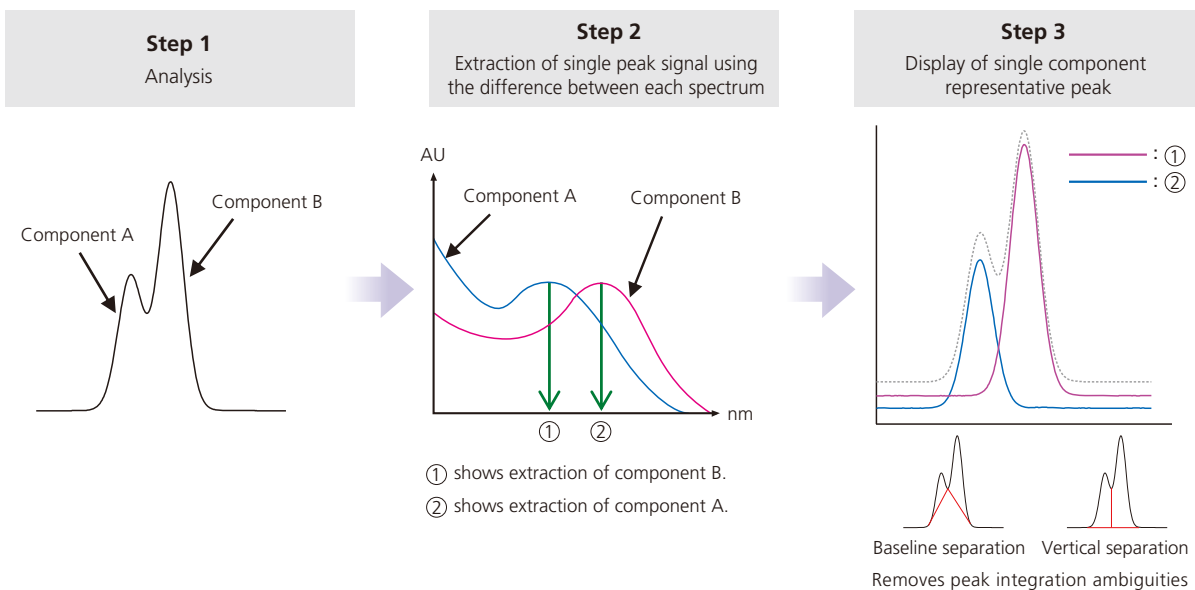

Example 1: Remove tailing peak

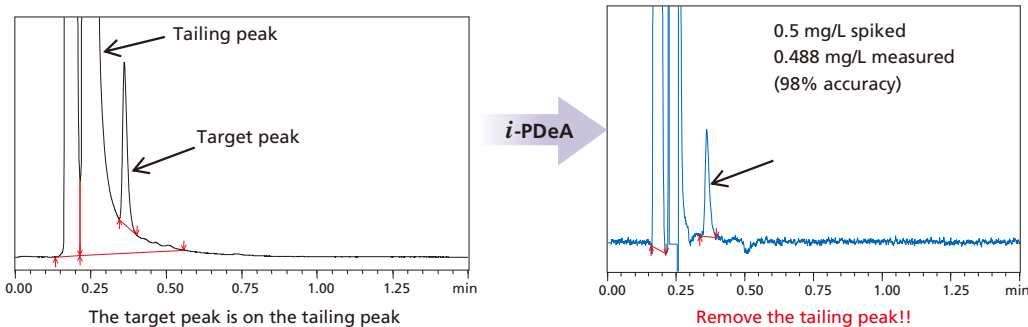

Example 2: Impurity peak extracted from co-eluted peak

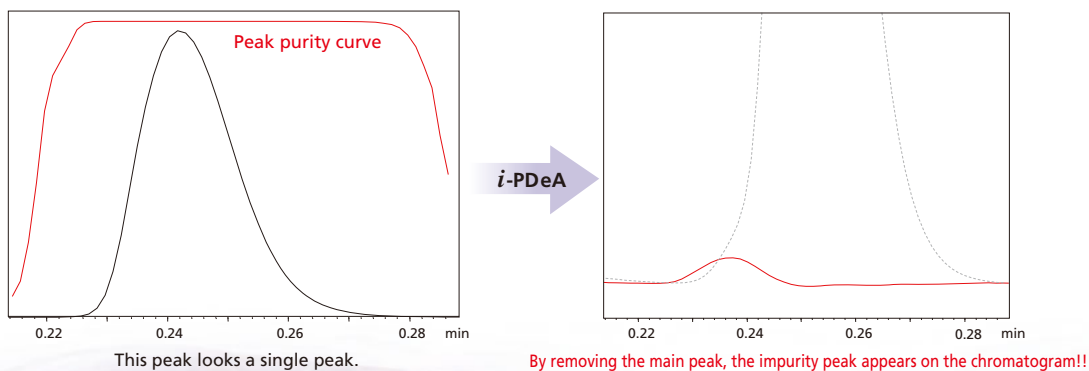

► ***i*-DReC** (intelligent Dynamic Range Extension Calculator, patent pending) **Dramatically Expands Dynamic Range**

When analyzing concentrated samples, chromatogram peaks can exceed the upper measurement limit values, which can prevent obtaining correct peak area values. *i*-DReC calculates target peak areas (or height) by determining the peak area (or height) of the chromatogram obtained at a wavelength with low absorption (λ_b) and multiplying the resulting value by a sensitivity coefficient (k), which is calculated from a section of the spectrum taken from the skirt of the target peak. The parameters used by the *i*-DReC function are mostly calculated automatically by the software. Therefore, the dynamic range can be expanded using simple operations.

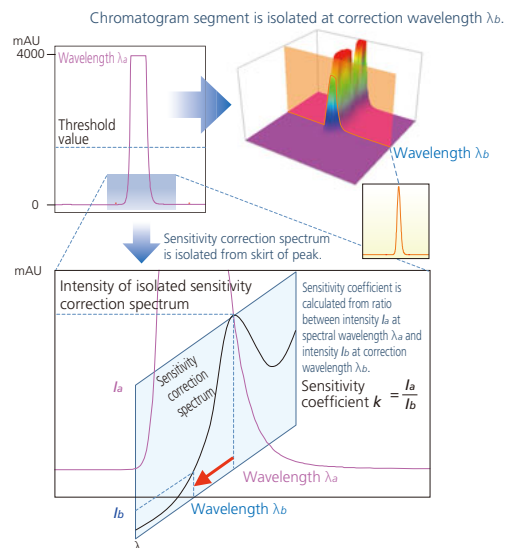

Example 1: Preparing Calibration Curve for Concentrated Sample

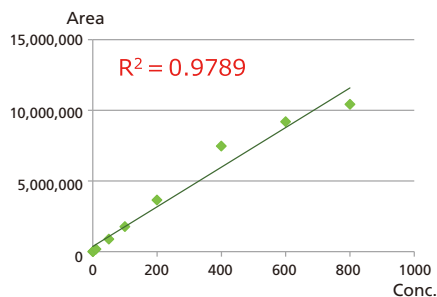

***i*-DReC**

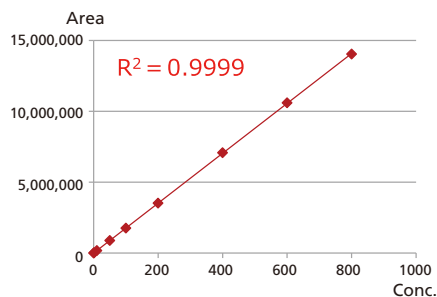

Calibration Curve with High-Concentration Calibration Points Obtained from Indomethacin Sample (Without *i*-DReC)

Calibration Curve with High-Concentration Calibration Points Obtained from Indomethacin Sample (With *i*-DReC)

Example 2: Simultaneous Quantitation of Principal Components and Impurities

With conventional methods, quantitation of both principal components and impurities requires analyzing two separate samples with different dilution rates and then correcting sample concentrations and peak area values based on the dilution rates. The *i*-DReC function, however, is capable of calculating the quantitative results for both principal components and impurities from the same set of acquisition data.

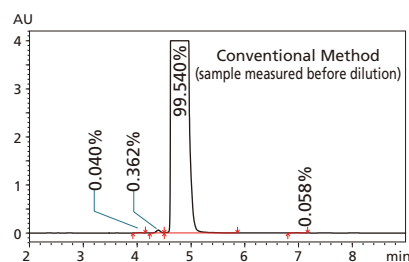

***i*-DReC**

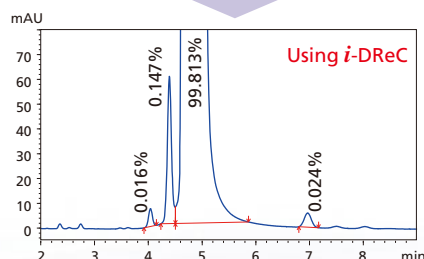

Using *i*-DReC provided almost the same results as the conventional method.

	Number of Acquisitions	Impurity 1	Impurity 2	Impurity 3
Conventional Method	2	0.013%	0.122%	0.026%
Using <i>i</i> -DReC	1	0.016%	0.147%	0.024%



Shimadzu Corporation

www.shimadzu.com/an/

Company names, product/service names and logos used in this publication are trademarks and trade names of Shimadzu Corporation or its affiliates, whether or not they are used with trademark symbol "TM" or "®".
Third-party trademarks and trade names may be used in this publication to refer to either the entities or their products/services. Shimadzu disclaims any proprietary interest in trademarks and trade names other than its own.

For Research Use Only. Not for use in diagnostic procedures.
The contents of this publication are provided to you "as is" without warranty of any kind, and are subject to change without notice. Shimadzu does not assume any responsibility or liability for any damage, whether direct or indirect, relating to the use of this publication.

© Shimadzu Corporation, 2015

Printed in Japan 3655-06527-20ANS